



IDEA ITALY

PASSION FOR OUTDOOR

*living*

GARDEN COLLECTION

LIVING EDITION 2026

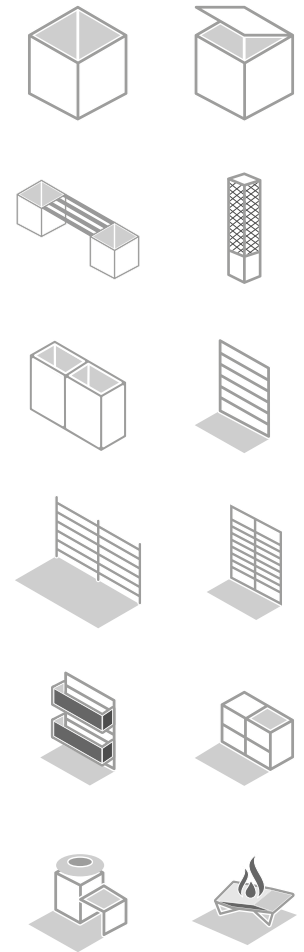

# LIVING COLLECTION

**IT** Idea Italy amplia la propria gamma di prodotti per la protezione solare inserendo complementi d'arredo per l'outdoor quali fioriere e pannelli frangivista, box contenitori, pareti brise soleil, cucine, bbq e bracieri.

**EN** Idea Italy expands its range of sun protection products to include outdoor furnishing accessories such as planters and shading panels, storage boxes, brise soleil walls, kitchens, bbqs and braziers.

**ES** Idea Italy amplía su gama de productos de protección solar incluyendo mobiliario de exterior, como maceteras y paneles de protección visual, cajas de almacenamiento, paredes brise soleil, cocinas, barbacoas y braseros.

## GARDEN

Fioriere Quadra | 4 

Panca e panchina Sedra | 7 

Box e contenitori | 8 

Esedra | 9 

Led | 10

Green balcony | 11 

Frangivista | 12 

Parete Velora | 16 

Green wall | 18 

Frame work | 20 

## COOKING

Cucina Kita | 24 

BBQ Extera | 30 

Braciere Ember | 34 

Idea Italy colours | 35



# GARDEN







# FIORIERE QUADRA

**IT** Robuste e resistenti, le nostre fioriere sono adatte per arredare piccoli balconi, grandi terrazzi e spaziosi giardini. Tutte le strutture sono realizzate con pannelli d'acciaio pressopiegato e verniciate a polvere con colori a scelta Idea Italy. Ogni fioriera è rivestita internamente di uno strato isolante, adatto ad ospitare il terriccio oppure una pratica mensola regolabile a diverse altezze, ed è integrabile con un pratico kit LED con alimentatore e piedini regolabili con appoggio in gomma.

**EN** Solid and resistant, our planters are suitable for furnishing small balconies, large terraces and spacious gardens. All structures are made of press-formed steel panels and powder-coated in the colours of Idea Italy's choice. Each planter is lined internally with an insulating layer, suitable for holding potting soil or a practical shelf adjustable to different heights, and can be integrated with a practical LED kit with power supply and adjustable feet with rubber support.

**ES** Robustas y duraderas, nuestras maceteras son adecuadas para amueblar balcones pequeños, terrazas grandes y jardines espaciosos. Todas las estructuras están fabricadas con paneles de acero plegados a presión y lacadas con pinturas en polvo en los colores Idea Italy. Cada macetera está revestida internamente con una capa aislante, adecuada para contener tierra o un práctico estante ajustable a diferentes alturas, y puede integrarse con un práctico kit LED con fuente de alimentación y pies ajustables con soporte de goma.







**IT** Fioriera con isolamento termico e vasca per acqua, piede regolabile, disponibile in diverse misure.

**EN** Planter with heat insulation, water basin and adjustable foot, available in different sizes.

**ES** Macetera con aislamiento térmico, cubeta para agua y pie ajustable, disponible en diferentes tamaños.

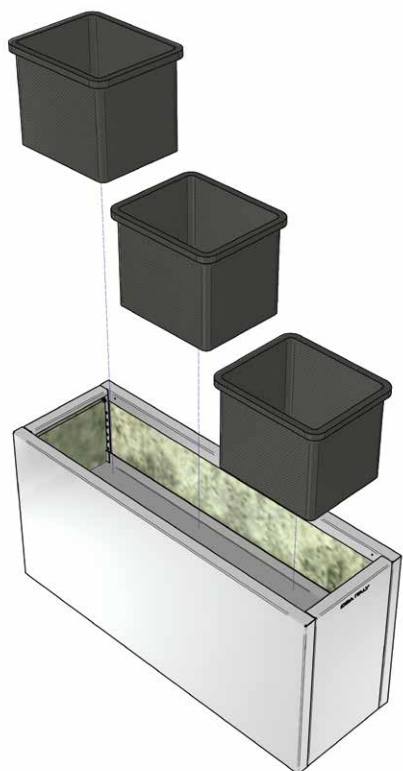

**IT** Fioriera con isolamento termico, mensola regolabile e vasi, piede regolabile, disponibile in diverse misure.

**EN** Planter with heat insulation, adjustable shelf, pots and adjustable foot, available in different sizes.

**ES** Macetera con aislamiento térmico, estante regulable y macetas, disponible en diferentes tamaños.

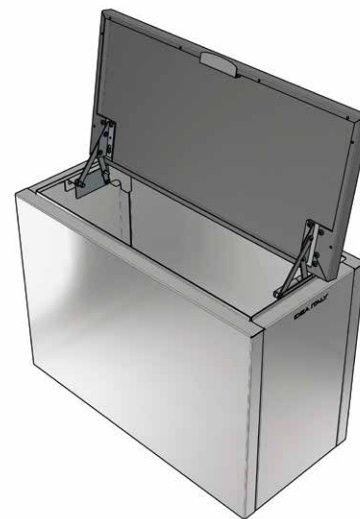

**IT** Box contenitore con coperchio a molle, compatibile con pannello posteriore e panca laterale.

**EN** Storage box with spring-loaded lid, compatible with rear panel and side bench.

**ES** Caja de almacenamiento con tapa de resorte, compatible con el panel trasero y el banco lateral.

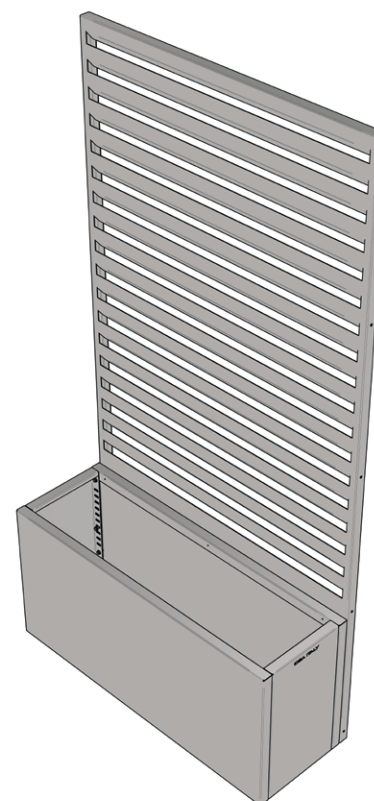

**IT** Fioriera con predisposizione pannello frangivista fissato alla struttura, in 2 lunghezze (72/104 cm) e differenti altezze (200/240 cm).

**EN** Planter with provision for a brise-soleil panel fixed to the structure, in 2 lengths (72/104 cm) and different heights (200/240 cm).

**ES** Macetera preparada para un panel de protección visual fijado a la estructura, en 2 largos (72/104 cm) y diferentes alturas (200/240 cm).

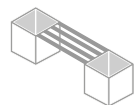

# PANCA E PANCHINA SEDRA

**IT** Le fioriere possono essere dotate di pratiche e robuste sedute da esterno in doghe d'acciaio. Disponibili con o senza schienale. Larghezza 100/150 cm. Colori Idea Italy.

**EN** The planters can be fitted with practical and strong outdoor seats made of steel slats. Available with or without backrest. Width 100/150 cm. Idea Italy colours.

**ES** Las maceteras pueden equiparse con prácticos y resistentes asientos de exterior fabricados con lamas de acero. Disponibles con o sin respaldo. Anchuras 100/150 cm. Colores Idea Italy.





# BOX E CONTENITORI QUADRA

**IT** Utili per riporre attrezzi da giardino, accessori barbecue o cuscini, i box possono contenere anche i diffusori per la musica o il sistema LED delle fioriere. Il coperchio apribile con molle è compatibile per il montaggio di un pannello frangivista posteriore. Integrabile con panca e panchina laterale

**EN** Suitable for storing garden tools, barbecue accessories or cushions, the boxes can also hold music speakers or the LED system for planters. The spring-loaded opening lid is compatible for mounting a rear privacy screen. Can be integrated with seat and side bench.

**ES** Útiles para guardar herramientas de jardín, accesorios de barbacoa o cojines, las cajas también pueden albergar altavoces de música o el sistema LED de las maceteras. La tapa de apertura por resorte es compatible para montar un panel de protección visual trasero. Puede integrarse con el asiento y el banco lateral.





# ESEDRA

**IT** La colonna Esedra è un elemento decorativo che completa le composizioni di fioriere, contenitori e panche. La colonna ornamentale in acciaio è fissabile alle fioriere oppure sul fondo. Disponibile in 2 altezze (cm 200 - cm 240).

**EN** The Esedra column is a decorative element that completes the compositions of planters, containers and benches. The ornamental steel column can be fixed to the planters or to the ground. Available in 2 heights (200 cm - 240 cm).

**ES** La columna Esedra es un elemento decorativo que completa las composiciones de maceteras, contenedores y bancos. La columna ornamental de acero se puede fijar a las maceteras o al fondo. Disponible en 2 alturas (200 cm - 240 cm).



# LED



**IT** Valorizza la tua fioriera e il tuo arredo anche di sera: un profilo in acciaio protegge la striscia a LED che proietta un fascio luminoso verso il basso.

**EN** Enhance your planter and furniture even at night: a steel profile protects the LED strip that projects a beam downwards.

**ES** Realce su macetera y su decoración incluso de noche: un perfil de acero protege la tira de LED que proyecta un haz de luz hacia abajo.





# GREEN BALCONY

**IT** Sistema modulare di parapetto per balconi che integra una fioriera con sistema di irrigazione e scarico dell'acqua, rivestito con pannelli in acciaio amovibili per eventuale manutenzione del verde.

**EN** Modular balcony railing system that integrates a planter with irrigation and drainage system, covered with removable steel panels for easy maintenance of the plants.

**ES** Sistema modular de barandilla para balcones que integra una macetera con sistema de riego y drenaje de agua, todo ello revestido con paneles de acero desmontables para el mantenimiento de la vegetación.



**IT** Adattabili a qualsiasi tipo di progetto e forniti con certificazione statica.

**EN** Adaptable to any type of project and supplied with static certification.

**ES** Adaptables a cualquier tipo de proyecto y suministrados con certificación estática.



# FRANGIVISTA

**IT** Pannelli verticali in acciaio con trattamento di cataforesi e verniciatura, da fissare posteriormente alla fioriera. Disponibili in due soluzioni personalizzabili: con lavorazione grafica a taglio laser oppure con alette pressopiegate per la regolazione della luce e della schermatura visiva.

**EN** Vertical steel panels with cataphoresis treatment and paint finish, to be fixed to the rear of the planter. Available in two customisable solutions: with laser-cut graphics or with press-formed fins for light adjustment and visual screening.

**ES** Paneles verticales de acero con tratamiento de catálisis y lacados, para fijar en la parte posterior de la macetera. Disponibles en dos soluciones personalizables: con diseño gráfico cortado con láser o con aletas plegadas a presión para regular la luz y la protección visual.



**IT** Esempio di posizionamento frangivista modulo ad angolo installato su piantoni fissati a terra.

**EN** Example of positioning a corner module privacy screen installed on posts fixed to the ground.

**ES** Ejemplo de colocación de un módulo rompevistas en ángulo instalado sobre postes fijados al suelo.



**IT** Modulo parete frangivista utilizzato come parete divisoria di aree esterne.

**EN** Privacy screen module used as a partition wall for outdoor areas

**ES** Módulo rompevistas utilizado como pared divisoria de zonas exteriores.





**IT** I pannelli frangivista possono essere installati su fioriere o box contenitori, ma anche fissati su montanti ancorati al suolo, garantendo solidità e versatilità di utilizzo. La disposizione può avvenire in linea oppure ad angolo, consentendo diverse soluzioni compositive in base alle esigenze di spazio. Oltre a svolgere un'efficace funzione di schermatura solare, i pannelli sono ideali come elementi divisori o per il confinamento e la gestione degli spazi esterni. Trovano infatti applicazione come riparo per biciclette, schermi per nascondere i cassonetti della raccolta differenziata o, più in generale, per migliorare l'ordine e l'estetica degli ambienti.



**EN** The privacy panels can be installed on planters or storage boxes, but also fixed to posts anchored to the ground, ensuring solidity and versatility of use. They can be arranged in a line or at an angle, allowing for different compositional solutions depending on space requirements. In addition to providing effective sun protection, the panels are ideal as dividers or for enclosing and managing outdoor spaces. They can be used as shelters for bicycles, screens to hide recycling bins or, more generally, to improve the order and aesthetics of outdoor areas.

**ES** Los paneles rompvistas pueden instalarse en maceteras o contenedores, pero también fijarse a montantes anclados al suelo, lo que garantiza solidez y versatilidad de uso. Pueden disponerse en línea o en ángulo, lo que permite diferentes soluciones compositivas en función de las necesidades de espacio. Además de desempeñar una eficaz función de protección solar, los paneles son ideales como elementos divisorios o para delimitar y gestionar los espacios exteriores. De hecho, se utilizan como refugio para bicicletas, pantallas para ocultar los contenedores de basura o, en general, para mejorar el orden y la estética de los entornos.

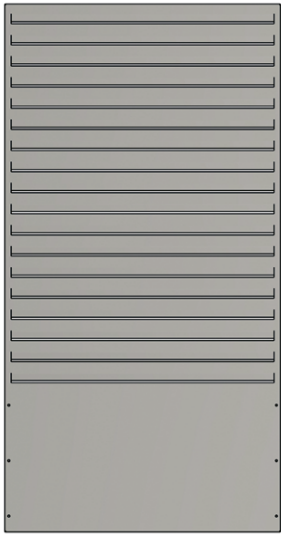

**COD. 02**  
(PASSAGGIO  
LUCE 8 MM)



**COD. 03**  
(PASSAGGIO  
LUCE 15 MM)

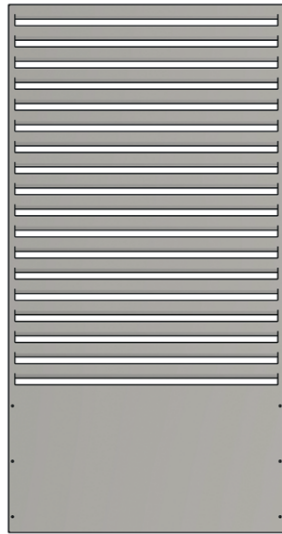

**COD. 04**  
(PASSAGGIO  
LUCE 25 MM)

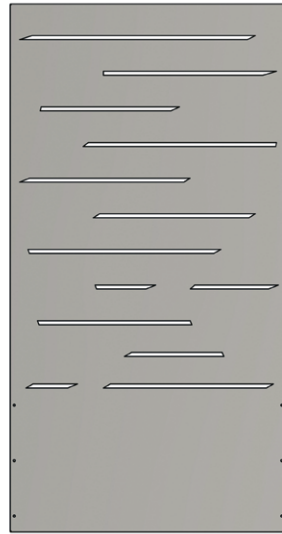

**COD. 05**



**COD. 06**



**COD. 07**  
(PIENO/DISEGNO  
LOGO CLIENTE)

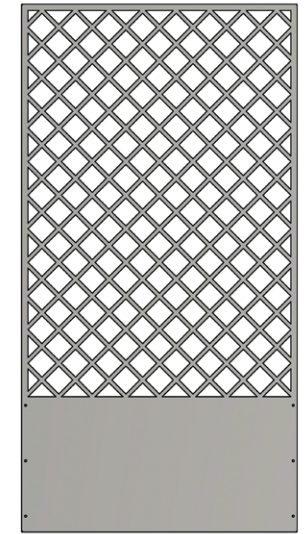

**COD. 10**

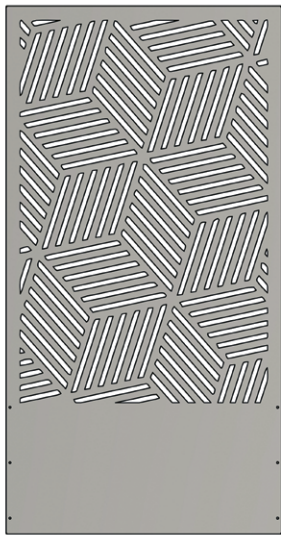

**COD. 11**

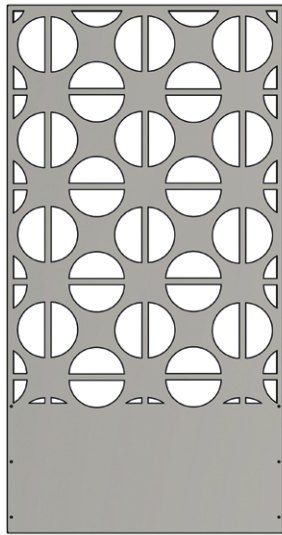

**COD. 12**

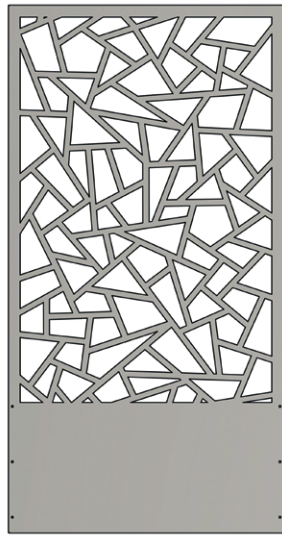

**COD. 13**

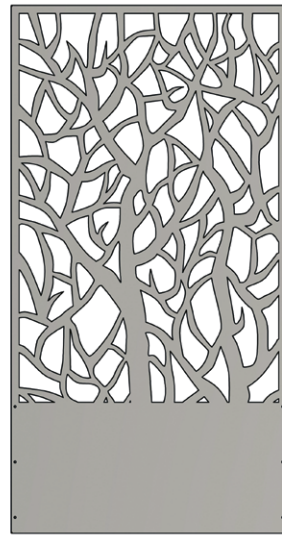

**COD. 14**

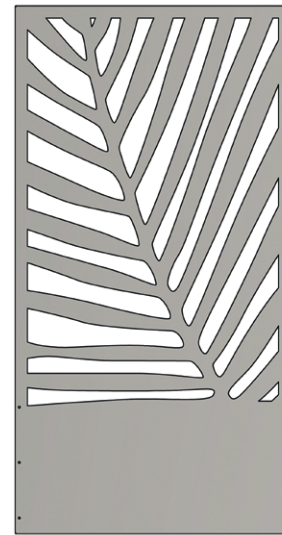

**COD. 15**

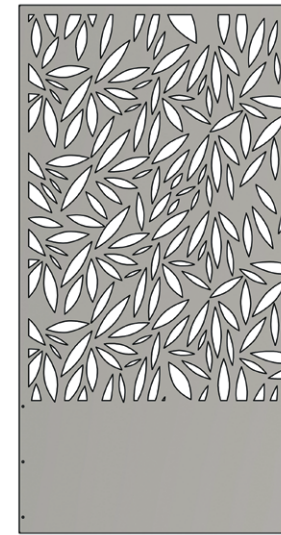

**COD. 16**

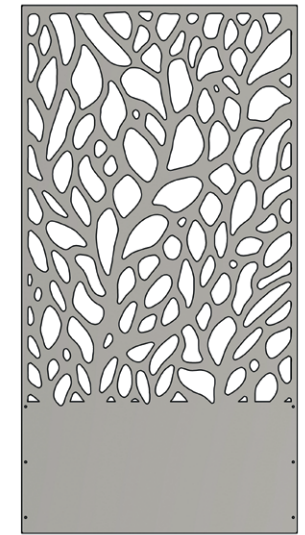

**COD. 17**

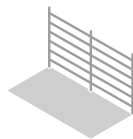

# PARETE VELORA



**IT** Velora è una parete verticale frangivista autoportante a doghe in alluminio, progettata per offrire privacy, comfort e valore estetico. È la soluzione ideale per delimitare aree e confini oppure per coprire e schermare contenitori per rifiuti, unità di climatizzazione e altre strutture tecniche. Le pareti autoportanti sono altamente personalizzabili, grazie alla possibilità di scegliere la luce tra le doghe, disponibile nelle seguenti varianti: 0 mm 8 mm 15 mm. I moduli sono disponibili con larghezza da 50 cm fino a 150 cm. L'altezza può raggiungere 220 cm nella versione autoportante, mentre arriva fino a 300 cm nella configurazione con fissaggio a soffitto tramite apposite staffe. Disponibili in tutte le varianti colori Idea Italy.

**EN** Velora is a freestanding vertical privacy screen made of aluminium slats, designed to offer privacy, comfort and aesthetic value. It is the perfect solution for defining areas and boundaries or for covering and screening waste bins, air conditioning units and other technical structures. The self-supporting walls are highly customisable, thanks to the possibility of choosing the gap between the slats, available in the following variants: 0 mm, 8 mm and 15 mm. The modules are available in widths from 50 cm to 150 cm. The height can reach 220 cm in the freestanding version, while it can reach up to 300 cm in the configuration with ceiling mounting using special brackets. Available in all Idea Italy colour variants.

**ES** Velora es una pared vertical rompevista autoportante con lamas de aluminio, diseñada para ofrecer privacidad, comodidad y valor estético. Es la solución ideal para delimitar áreas y límites o para cubrir y ocultar contenedores de basura, unidades de climatización y otras estructuras técnicas. Las paredes autoportantes son altamente personalizables, gracias a la posibilidad de elegir la luz entre las lamas, disponible en las siguientes variantes: 0 mm, 8 mm y 15 mm. Los módulos están disponibles de 50 cm a 150 cm de ancho. La altura puede alcanzar los 220 cm en la versión autoportante, mientras que llega hasta los 300 cm en la configuración con fijación al techo mediante soportes especiales. Disponibles en todas las variantes de colores Idea Italy.





# GREEN WALL

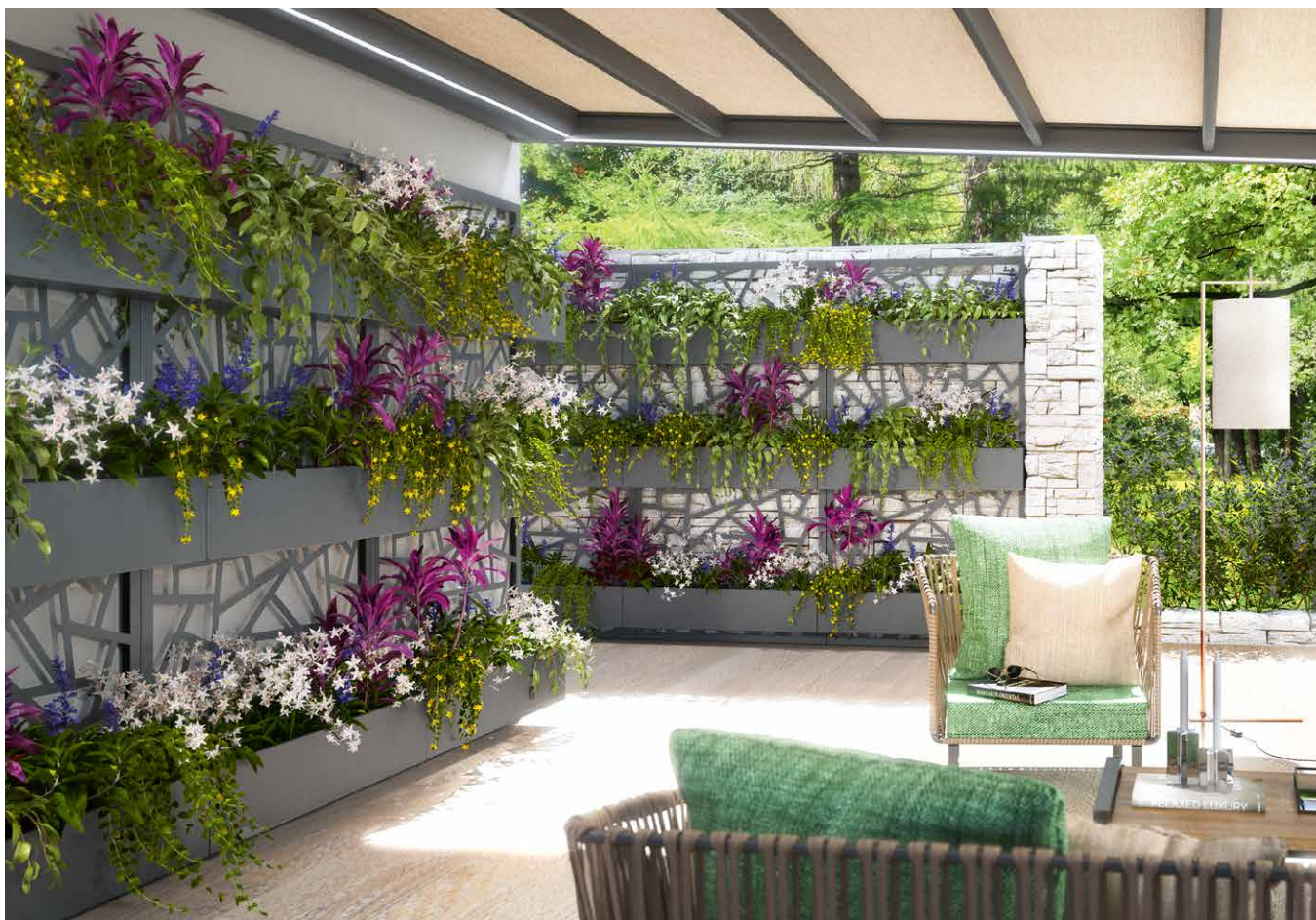

**IT** I pannelli frangivista Green Wall in acciaio sono progettati per l'installazione a parete mediante apposite staffe di fissaggio, garantendo stabilità e semplicità di montaggio. Possono essere completati con portavasi coordinati, applicabili in configurazione lineare oppure in libera installazione, permettendo di creare composizioni personalizzate che uniscono funzionalità ed elemento decorativo. Ideali per arredare e valorizzare gli spazi outdoor oppure per la riqualificazione estetica di una parete, i pannelli sono disponibili in tutte le grafiche e finiture colore Idea Italy, per una perfetta integrazione con qualsiasi contesto architettonico.

**EN** Green Wall steel privacy panels are designed for wall installation using special fixing brackets, ensuring stability and ease of assembly. They can be complemented with matching plant holders, which can be applied in a linear configuration or installed freely, allowing you to create customised compositions that combine functionality and decorative elements. Ideal for furnishing and enhancing outdoor spaces or for the aesthetic redevelopment of a wall, the panels are available in all Idea Italy graphics and colour finishes, for perfect integration with any architectural context.

**ES** Los paneles rompevistas Green Wall de acero están diseñados para su instalación en pared mediante soportes de fijación específicos, lo que garantiza estabilidad y facilidad de montaje. Se pueden completar con maceteros a juego, que se pueden colocar en configuración lineal o de forma libre, lo que permite crear composiciones personalizadas que combinan funcionalidad y elemento decorativo. Ideales para decorar y realzar los espacios exteriores o para la remodelación estética de una pared, los paneles están disponibles en todos los diseños y acabados de color de Idea Italy, para una perfecta integración en cualquier contexto arquitectónico.





# FRAME WORK

**IT** Telaio autoportante in alluminio, utilizzabile sia come schermatura solare sia come elemento architettonico decorativo, capace di coniugare funzionalità, solidità strutturale ed estetica contemporanea. La tipologia delle doghe e la loro densità così come la dimensione della struttura e gli elementi di fissaggio, sono personalizzabili a seconda del progetto.

**EN** Free-standing aluminium frame, which can be used both as sun protection and as a decorative architectural element, combining functionality, structural strength and contemporary aesthetics. The type of slats and their density, as well as the size of the structure and the fixing elements, can be customised according to the project.

**ES** Marco autoportante de aluminio, que puede utilizarse tanto como protección solar como elemento arquitectónico decorativo, capaz de combinar funcionalidad, solidez estructural y estética contemporánea. El tipo de lamas y su densidad, así como el tamaño de la estructura y los elementos de fijación, se pueden personalizar en función del proyecto.

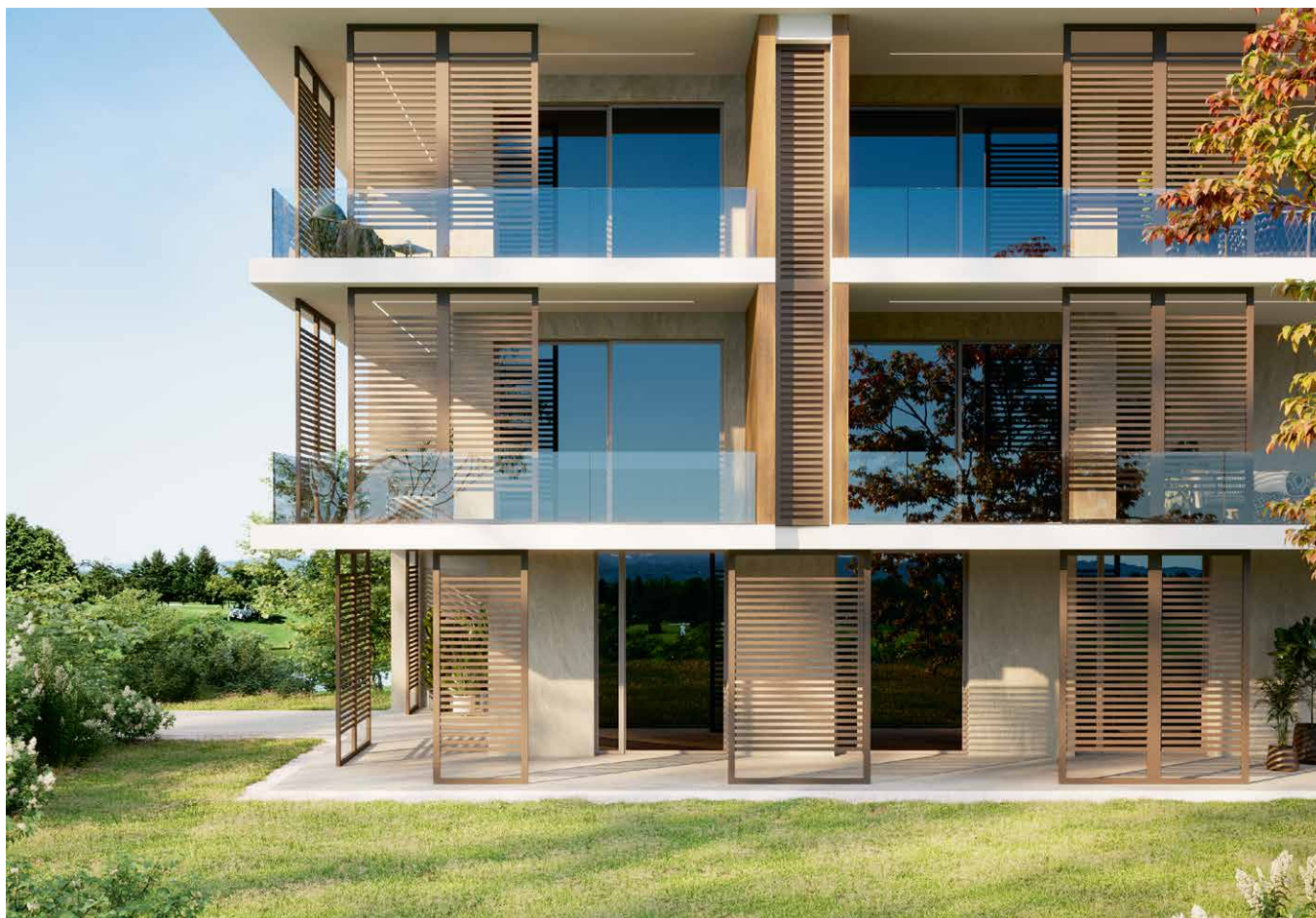





# COOKING







# CUCINA KITA

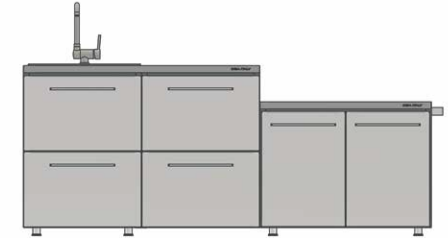

**IT** La nostra cucina con linee pulite ed essenziali, è perfetta per tutti gli ambienti. Ottimizzata per l'uso all'aperto, la struttura in acciaio con trattamento di cataforesi e verniciatura a polvere è disponibile in tutti i colori Idea Italy. Il top e le maniglie sono in acciaio inox satinato; i cassetti scorrono su guide telescopiche e i piedini sono regolabili.

**EN** Our kitchen, with its clean, minimalist lines, is perfect for any environment. Optimised for outdoor use, the steel structure with cathoresis treatment and powder coating is available in all Idea Italy colours. The top and handles are in satin-finish stainless steel; the drawers slide on telescopic runners and the feet are adjustable.

**ES** Nuestra cocina, con líneas limpias y esenciales, es perfecta para cualquier ambiente. Optimizada para su uso en exteriores, la estructura de acero con tratamiento de catálisis y pintura en polvo está disponible en todos los colores de Idea Italy. La encimera y los tiradores son de acero inoxidable satinado; los cajones se deslizan sobre guías telescópicas y los pies son ajustables.







**IT** Il piano cucina può essere completato con un tavolo snack abbattibile e con un pannello antivento attrezzato, dotato di porta-accessori e illuminazione LED integrata per la zona lavello e cottura.

**EN** The kitchen worktop can be completed with a fold-down snack table and a windbreak panel equipped with accessory holders and integrated LED lighting for the sink and cooking area .

**ES** La encimera de la cocina se puede completar con una mesa plegable y un panel cortaviento equipado con porta-accesorios e iluminación LED integrada para la zona del fregadero y de cocción.



**IT** È possibile personalizzare la cucina scegliendo tra moduli in diverse misure, funzionalità e configurazioni. Il piano unico in acciaio inox satinato unisce gli elementi nella parte superiore, valorizzandoli come un unico blocco continuo. Le configurazioni consentono l'inserimento di elettrodomestici integrabili, quali mini frigoriferi e cantinette refrigeranti ed alloggiamenti per l'alimentazione a gas.

**EN** You can customise your kitchen by choosing from modules in different sizes, with different functions and configurations. The single satin-finish stainless steel worktop joins the elements at the top, enhancing them as a single continuous block. The configurations allow for the inclusion of integrated appliances, such as mini fridges and wine coolers, and gas supply housings.

**ES** Es posible personalizar la cocina eligiendo entre módulos de diferentes tamaños, funcionalidades y configuraciones. La encimera única de acero inoxidable satinado une los elementos de la parte superior, realizándolos como un único bloque continuo. Las configuraciones permiten la incorporación de electrodomésticos integrables, como minineveras y vinotecas, y alojamientos para la alimentación de gas.

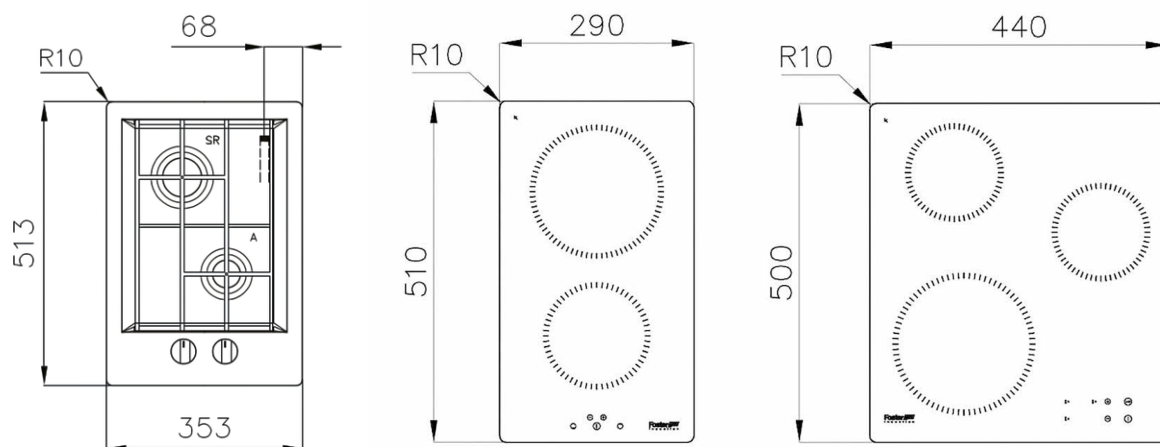
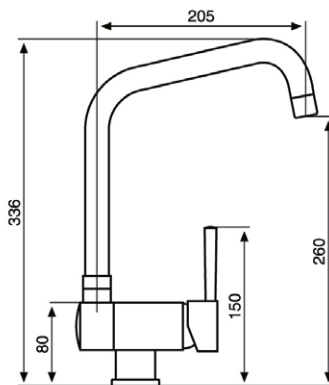
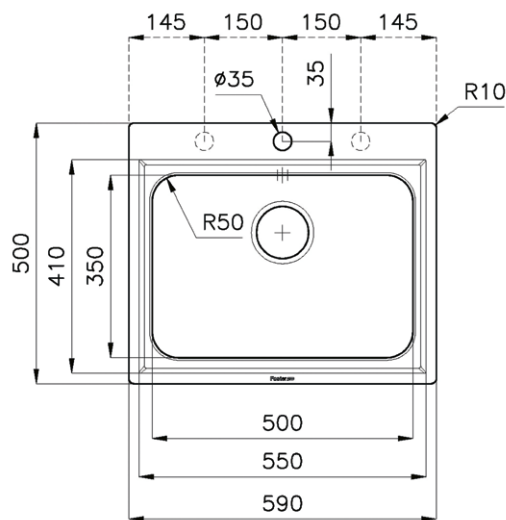

**IT** La cucina Kita può essere accessoriata con coperchio in alluminio verniciato per lavello e piano cottura, telo in PVC antipolvere, kit pattumiera per modulo da 60 cm, barra laterale porta-accessori, tagliere in legno per lavello EVO. Il lavello EVO in inox spazzolato (59 × 50 cm) è fornito completo di piletta, sifone e accessori e miscelatore inox Drop, con canna girevole e abbattibile. Disponibile il piano cottura a gas a 2 fuochi in inox spazzolato, o in alternativa il piano ad induzione a 2 o 3 fuochi ad alta efficienza.

**EN** The Kita kitchen can be equipped with a painted aluminium cover for the sink and hob, a PVC dust cover, a waste bin kit for the 60 cm module, a side bar for accessories, and a wooden chopping board for the EVO sink. The brushed stainless steel EVO sink (59 × 50 cm) comes complete with drain, siphon and accessories, and a Drop stainless steel mixer tap with swivel and fold-down spout. A 2-burner gas hob in brushed stainless steel is available, or alternatively a high-efficiency 2 or 3-burner induction hob.

**ES** La cocina Kita puede equiparse con una tapa de aluminio lacado para el fregadero y la placa de cocción, una cubierta antipolvo de PVC, un kit de cubo de basura para el módulo de 60 cm, una barra lateral porta- accesorios y una tabla de cortar de madera para el fregadero EVO. El fregadero EVO de acero inoxidable cepillado (59 × 50 cm) se suministra completo con desagüe, sifón y accesorios, y grifo mezclador Drop de acero inoxidable, con caño giratorio y abatible. Disponible la placa de cocción a gas de 2 fuegos en acero inoxidable cepillado o, alternativamente, la placa de inducción de 2 o 3 fuegos de alta eficiencia



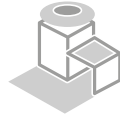

# BBQ EXTERA



**IT** Il BBQ a legna è l'ideale per chi cerca una combinazione perfetta di prestazioni e stile. Il disco di cottura ad alto spessore assicura la cottura perfetta di tutte le pietanze. Realizzato in lamiera pressopiegata, garantisce un'elevata rigidità e durata nel tempo. Il comodo tavolino laterale in acciaio inox consente di avere sempre a portata di mano gli utensili e i cibi da cucinare.

**EN** The wood-fired BBQ is perfect for users looking for the right combination of performance and style. The thick cooking disc ensures perfect cooking of all dishes. Made of pressed sheet metal, it guarantees high rigidity and durability. The practical stainless steel side table ensures that cooking utensils and food are always ready at hand.

**ES** La barbacoa de leña es ideal para quienes buscan la combinación perfecta de rendimiento y estilo. El grueso disco de cocción garantiza una cocción perfecta de todos los platos. Fabricado en chapa plegada a presión, garantiza una gran rigidez y durabilidad. La práctica mesa lateral de acero inoxidable mantiene los utensilios de cocina y los alimentos al alcance de la mano en todo momento.







**IT** Nel modulo di supporto del disco si trovano il cassetto portacenere completamente estraibile, la leva di regolazione del flusso d'aria in ingresso e un pratico vano porta legna. La griglia/bistecchiera ruota a 360° ed è regolabile in altezza per un miglior controllo delle fasi di cottura. Completamente rimovibile, permette di accedere al vano braciere senza impedimenti.

**EN** In the disc support module you will find the fully removable ash tray, the lever for adjusting the inlet air flow and a practical wood storage compartment. The grill/broiler rotates through 360° and is height-adjustable for better control of the cooking process. Completely removable, it allows unhindered access to the grate compartment.

**ES** En el módulo de soporte del disco encontrará el cajón de cenizas totalmente extraíble, la palanca para ajustar el flujo de aire de entrada y un práctico compartimento para guardar la leña. La parrilla / bandeja para asados gira 360° y es regulable en altura para un mejor control del proceso de cocción. Completamente desmontable, permite un acceso sin obstáculos al brasero.





# BRACIERE EMBER

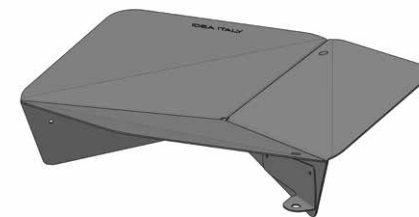

**IT** Il braciere a legna Ember è un robusto vassoio autoportante costruito in corten ad alto spessore. Il disco ha un diametro esterno di 80 cm e appoggia su tre punti per non trasmettere calore a terra.

**EN** The Ember wood-burning brazier is a robust, self-supporting tray made of thick Corten. The disc has an external diameter of 80 cm and rests on three points so as not to transmit heat to the ground.

**ES** El brasero de leña Ember es una bandeja robusta y autoportante fabricada en corten grueso. El disco tiene un diámetro exterior de 80 cm y se apoya en tres puntos para no transmitir calor al suelo.





# IDEA ITALY COLOURS

**IT** L'ampia gamma di colorazioni consente di individuare la giusta tonalità della struttura da inserire nel vostro ambiente. Dai colori più moderni alle tinte più classiche, tutti realizzati con pigmenti di altissima qualità, per durare nel tempo. Disponibili su richiesta la gamma completa RAL e la finitura legno, ottenuta per sublimazione.

**EN** The wide range of colours allows you to find the right shade of structure for your environment. From the most modern colours to the most classic shades, all made with high quality pigments, to last over time. A full range of RAL colours and a sublimation wood finish are available on request.

**ES** La amplia gama de colores le permite encontrar el tono de estructura adecuado para su entorno. Desde los colores más modernos hasta los tonos más clásicos, todos ellos realizados con pigmentos de alta calidad, para que duren en el tiempo. Se puede pedir una gama completa de colores RAL y un "efecto madera", obtenido mediante sublimación.

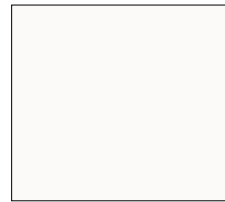

BIANCO 9010  
MATT

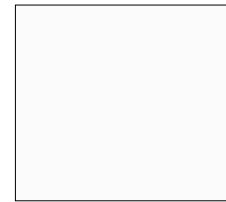

BIANCO IDEA  
TEXTURED

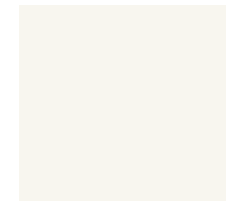

AVORIO 1013  
TEXTURED

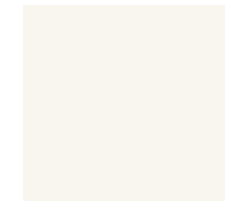

AVORIO 1013  
MATT

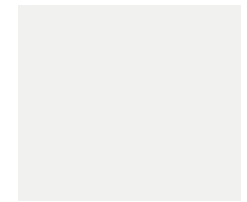

GRIGIO 7035  
MATT

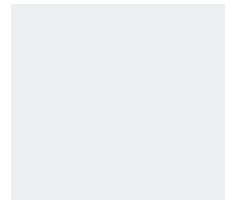

SILVER  
TEXTURED

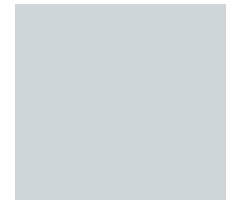

ARGENTO 7001  
TEXTURED

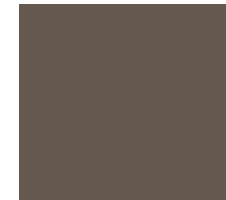

GRAPHITE  
TEXTURED



ANTRACITE 7016  
MATT



ANTRACITE 7016  
TEXTURED



NERO 9005  
TEXTURED

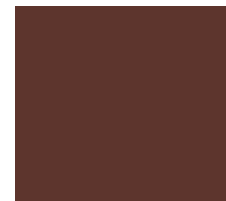

MARRONE 8017  
TEXTURED

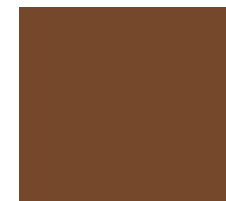

CORTEN  
TEXTURED



QUARZO  
TEXTURED



TORTORA  
TEXTURED

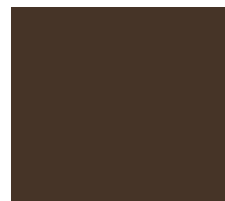

MOCHA  
TEXTURED



VERDE IDEA  
TEXTURED

A series of horizontal dashed lines spanning the width of the page, intended for writing or drawing.



A series of horizontal dashed lines spanning the width of the page, providing a template for writing or drawing.



Credits:  
Layout by Idea Italy

Tutte le immagini presenti su questo catalogo sono di proprietà di idea+ srl. Ne è vietata qualsiasi riproduzione non autorizzata. Le informazioni contenute in questo catalogo possono subire variazioni a fronte di un aggiornamento di prodotto.

All images in this catalogue are the property of idea+ srl. Any unauthorised reproduction is prohibited. The information contained in this catalogue is subject to change due to product updates.

Todas imágenes de este catálogo son propiedad de Idea+ srl. Queda prohibida cualquier reproducción no autorizada. La información contenida en este catálogo podría estar sujeta a cambios debido a las actualizaciones de los productos.

Idea+ srl

Registered office:  
Via Emilia Romagna 14  
46029 Suzzara (MN)

Operational headquarters:  
Via Che Guevara 13  
42045 Luzzara (RE)

 <https://www.facebook.com/passionXoutdoor>

 [https://www.instagram.com/ideaitaly\\_passionforoutdoor/](https://www.instagram.com/ideaitaly_passionforoutdoor/)





IDEA ITALY  
PASSION FOR OUTDOOR



OUTDOOR  
COLLECTION  
GENERAL EDITION



GARDEN  
COLLECTION  
LIVING EDITION

IDEA+ srl  
Registered office:  
Via Emilia Romagna 14  
46029 Suzzara (MN)

Operational headquarters:  
Via Che Guevara 13  
42045 Luzzara (RE)

[info@ideaitaly.it](mailto:info@ideaitaly.it)